

Description

RK is a range of straight flow in-line centrifugal duct fans designed for rectangular ducts. They are compact, high capacity fans which operate quietly and can be fitted in any position. RK fans have forward curved impellers and are designed to cope with high pressure and long duct. The fans have a rigid housing made from galvanised steel. They are moisture proof and approved for use in outdoor environments. The motors are maintenance free and protected from overheating by thermo contacts. The impellers only require occasional cleaning. This cleaning is made easy with the RK's swing out design. All fans are supplied fully wired and ready to fit in a sealed installation unit. The fans are not intended for transporting grinding dust, soot or similar. RK fans come in 8 sizes, which gives a total of 24 different capacities.



Technical data

Parameter	Value	Unit
Voltage	230	V
Phase	1	~
Frequency	50	Hz
Power	0.22	kW
Current	0.95	A
R.p.m.	815	r/m
Max. temperature of transported air	40	°C
Max. temperature of transported air when speed-controlled	40	°C
Sound pressure level at 3 m	50	dB(A)
Length	502	mm
Width	443	mm
Height	264	mm
Weight	11	kg
Enclosure class, motor	44	IP
Insulation class, motor	F	
Capacitor	6	µF
Duct connection	400x200 mm	

Diagrams

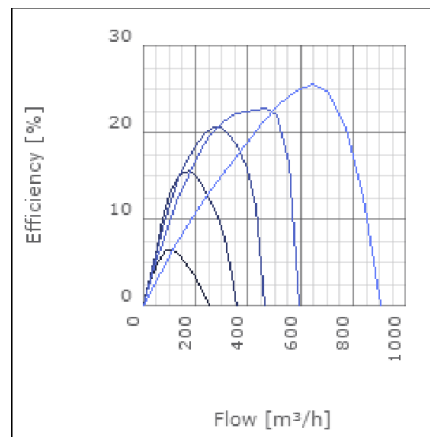
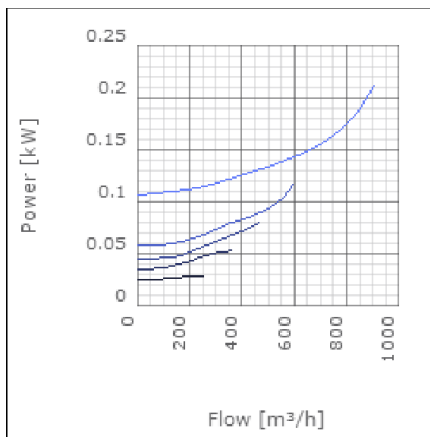
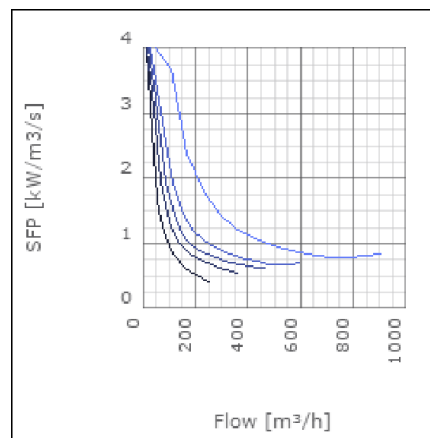
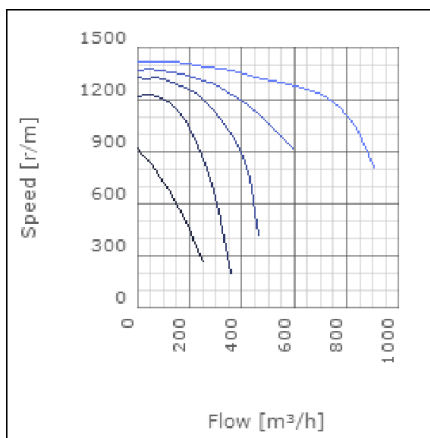
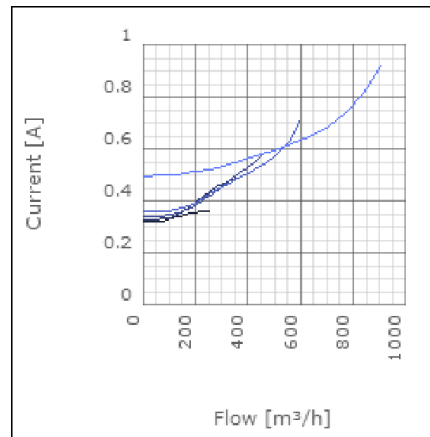
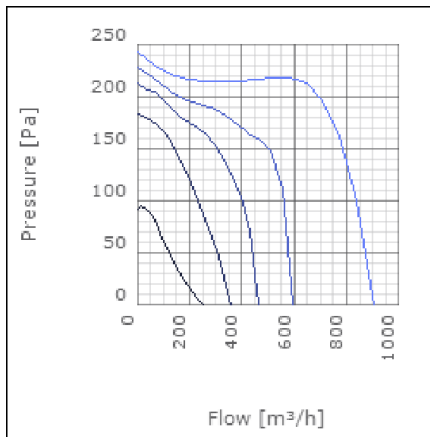

Sound

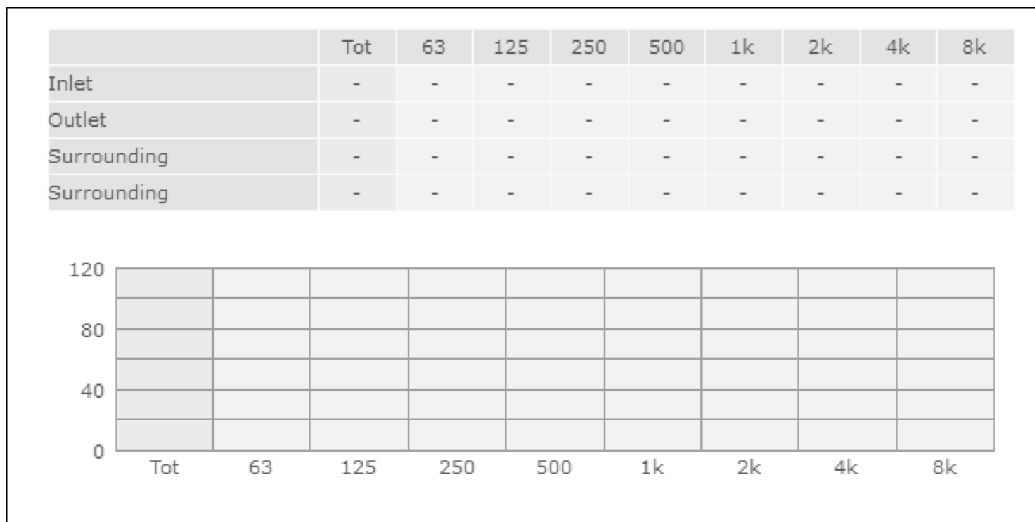
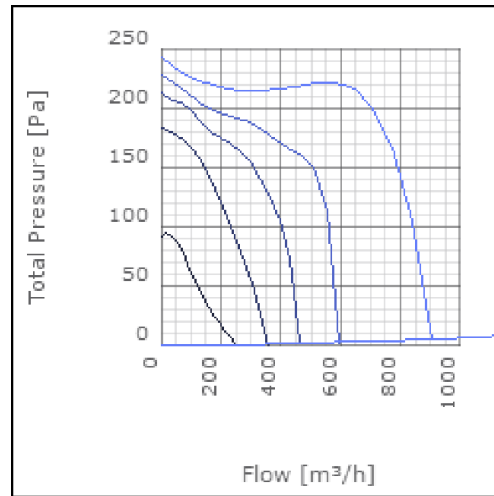
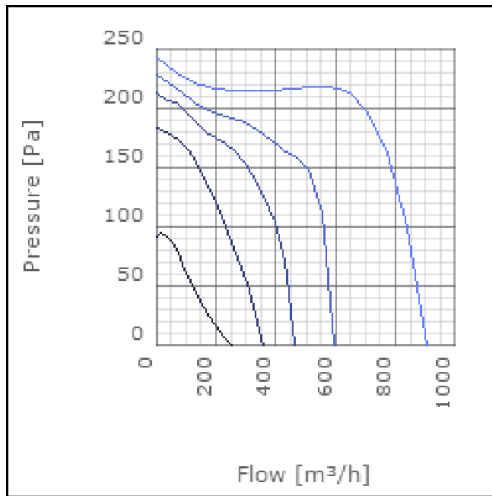

Parameter

Distance: 3.000
 Propagation type: Hemi-spherical
 Equivalent absorption area: 20.00

Dimensions

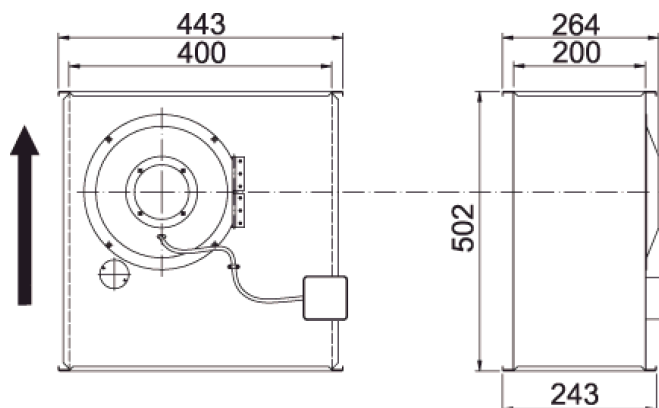

Wiring diagram

4040001

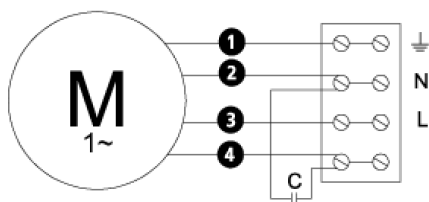

- (M) = Fan Motor
- (M1) = Fan Motor
- (M2) = Fan Motor
- (M3) = Rotor Motor
- 1 = Yellow/Green
- 2 = Black
- 3 = Blue
- 4 = Brown
- 5 = White (TW)
- 6 = Orange
- 7 = Grey
- 8 = Red
- 9 = Green
- 10 = Violet

Accessories

ETFV-94A
FRE 6
VRDE 1,5
VRS 1,0
VRTE 1

Electrical accessories

FLR 400x200
DS 400x200
RKC-Kit 200 (400x200)
LDR 400x200